

THE WEDGE IS THE HEART OF GATE VALVES



DO NOT
COMPROMISE
WITH QUALITY

Expect... **AVR**

WHAT IF AT BIRTH, YOU WERE ABLE TO CHOOSE?



Would you choose a cheap heart which breaks down - sending you in and out of hospitals - or would you choose a quality heart that remains healthy and strong throughout your entire life?

Just like you - a valve has a long lifespan

Throughout their youth, all valves do well - but with time, wear and tear takes its toll, and the differences between good and bad quality become apparent. The healthy quality valve will continue performing effortlessly, whilst the cheap valve will require more and more maintenance - at a very high cost!

The wedge constitutes the heart of the valve. It must travel easily and remain 100% tight for half a century. Don't compromise with something as important as the heart of the valve.

Get to know the differences between the healthy strong valves and those that are not - and let us tell you why your choice should be an AVK valve.

More than meets the eye

When you choose a valve from AVK you get 50 years of dedication and experience, you get research and development on the highest level, and you get products made from the best raw materials and produced under supervised and well-documented production processes. You also get a number of international approvals and certifications. This guarantees that our products live up to our promises!

With an AVK wedge, you give heart to a long and healthy life for your network with minimum maintenance and long-term savings.



Long durability



Short durability





RESILIENT SEATED GATE VALVES FOR AN UPDATED NETWORK



A resilient seated gate valve has a plain valve bottom allowing free passage for sand and pebbles in the valve. If impurities pass as the valve closes, the rubber surface will close around the impurities while the valve is closed.



The rubber absorbs impurities

A correct rubber compound is soft enough to absorb impurities, yet strong enough to wash the impurities through when the valve is opened again. This means that the rubber surface will regain its original shape securing a drop-tight sealing. Tests prove that the rubber surface of a DN150 wedge absorbs impurities up to Ø8.7 mm.

More great features

- Low torques with a large safety margin
- Wedge guides for safe shut-off function
- Fixed wedge nut
- Corrosion free wedge
- Resistant to differential pressures from -0.8 bar to 25 bar
- Approved for drinking water.

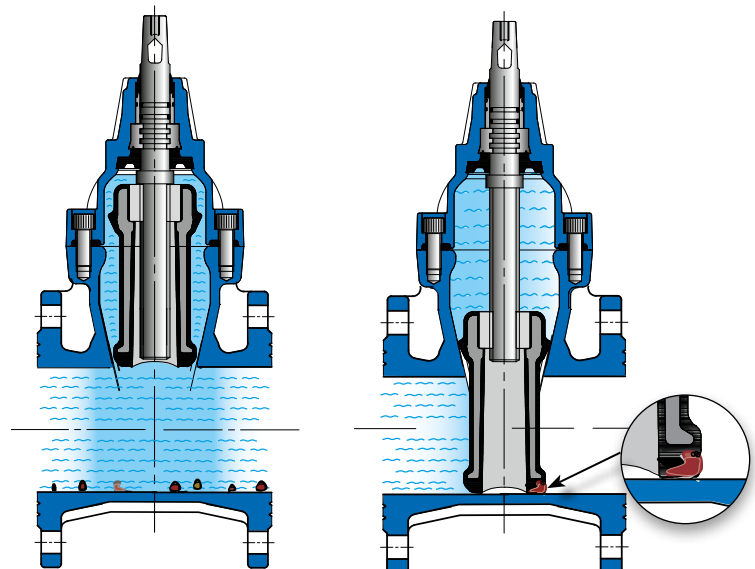

METAL SEATED GATE VALVES REPLACED BY A BETTER SOLUTION



Old metal seated type

Before the resilient seated gate valve was introduced to the market, gate valves with a metal seated wedge were used. The conical wedge design and angular sealing devices of a metal seated wedge require a depression in the valve bottom to ensure a tight closure. Herewith, sand and pebbles are embedded

in the bore. The pipe system will never be completely free from impurities regardless of how thoroughly the pipe is flushed upon installation or repair. Thus any metal wedge will eventually lose its ability to be drop-tight.

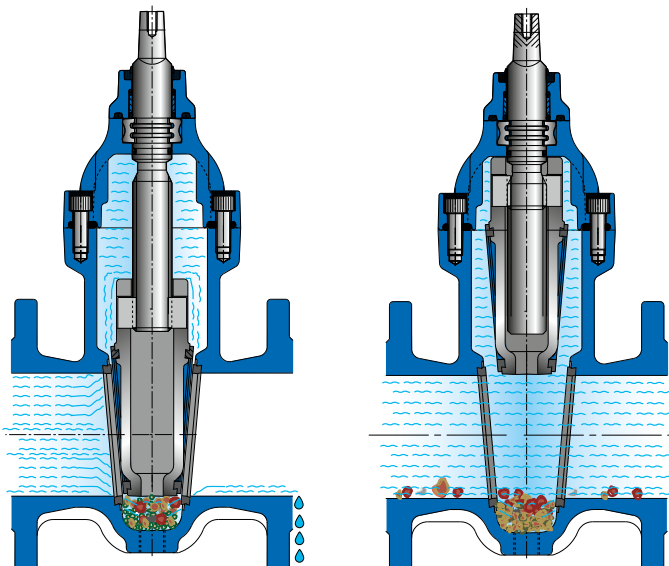
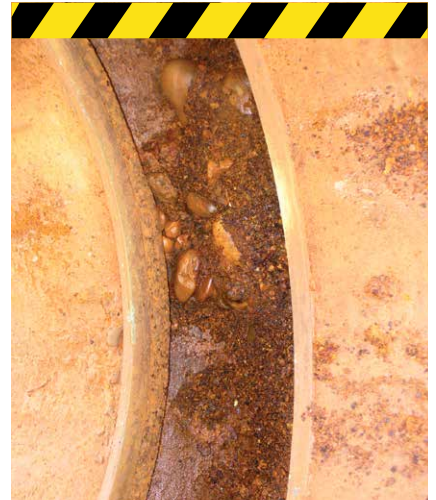

Metal seated competitor valve

Notice how sand and pebbles have settled in the sump. A metal seated valve does not close tightly when sand and pebbles are embedded in the bore.

FIXED WEDGE NUT ENSURES SAFE OPERATION

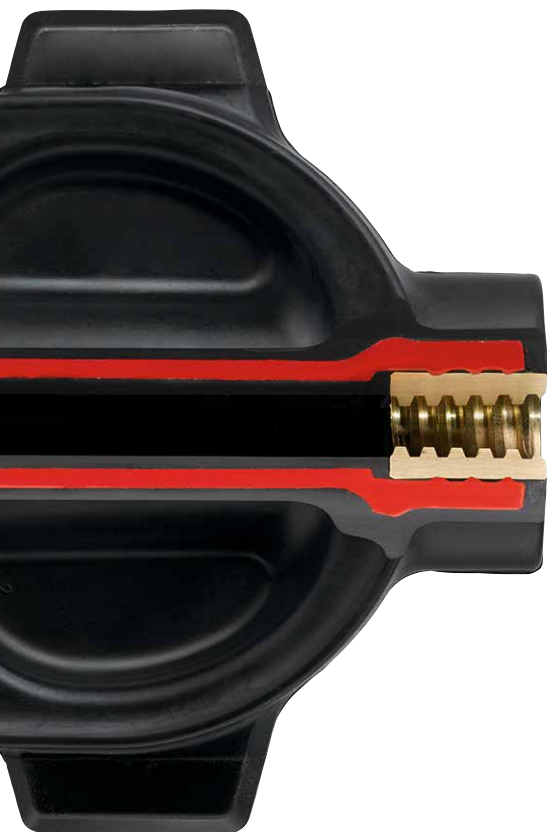

Safe operation and long durability

A fixed wedge nut reduces the number of moveable parts and prevents vibration and thus also corrosion and malfunction.

The wedge nut is made of dezincification resistant low-lead brass with lubricating abilities which provides optimum compatibility with the stainless steel stem. It is sealed at the top and bottom with rubber to prevent corrosion.

A wedge design with a fixed wedge nut offers superior performance but it also requires accurate and efficient wedge guides in order to make sure that the stem does not bend at extreme flow velocity and that the wedge has an equal operating torque during the entire process from open to closed position.

The wedge stop on the stem provides a firm stop against the wedge nut when opening the valve. This prevents the wedge from compressing the stem seals and from damaging the coating inside the bonnet resulting in prolonged durability of the valve.



LOOSE WEDGE NUT VULNERABLE TO CORROSION



Corrosion and high operating torques

One of the most noticeable disadvantages of a loose wedge nut is that it is difficult to vulcanise inside the bayonet socket in the wedge. At best, a thin rubber layer is vulcanised only to be worn through.

The loose wedge is influenced by the flow, and the vibration of the wedge will lead to abrasion on the wedge. The rubber layer on the bayonet will soon be worn through, and corrosion will occur.

The operating torque will be increased dramatically during high flow velocity as a wedge with a loose wedge nut has a tendency to "edge" the valve body, causing an increased friction between the rubber and the inside epoxy coating.



Most gate valves are designed with a loose wedge nut placed in a bayonet socket in the wedge, where it is difficult to obtain sufficient rubber vulcanisation. The loose wedge vibrates when influenced by the flow which leads to abrasion of the thin rubber layer.

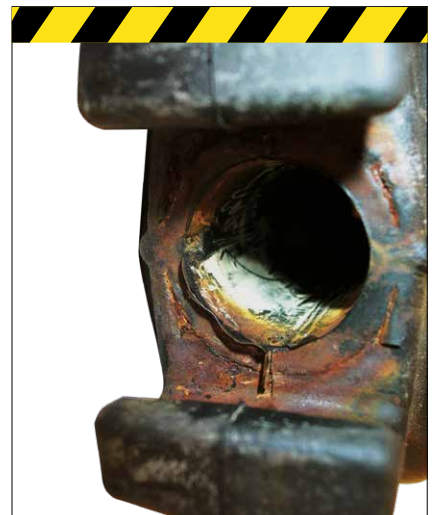

FULLY VULCANISED WEDGE DESIGNS



AVK wedges are designed with accurate wedge guides that comply with very low tolerances. This requires a thorough vulcanisation of the rubber.

Protection against wear

The wedge guide rails and wedge shoes ensure a smooth operation and keep the operating torque to a minimum. The wedge shoes ensure that AVK supersedes the life time requirements stated in EN 1074-2. Even at maximum differential pressures and high flow velocities the friction between the body and wedge is kept to a minimum.

A unique vulcanisation process ensures that the entire wedge core is covered with rubber and that the shoes are attached to the wedge core. This process is one of the secrets keeping

the wedge protected from corrosion and thus securing a long service life and smooth operation of the valve.

High quality rubber compounds

AVK uses rubber compounds durable enough to resist repeated open/close operations. Furthermore, the friction against the valve body's internal epoxy coating is very low with this rubber quality, whereby very low operating torques and closing torques are achieved.

The ductile iron core is fully vulcanised with rubber both inside and outside. A minimum

of 1.5 mm rubber is applied on all pressure bearing surfaces and a minimum of 4 mm on all sealing surfaces regardless of the design.



INADEQUATE WEDGE VULCANISATION



Consequences of bad vulcanisation

The photos show other brands with loose wedge shoes. The vulcanisation is particularly inadequate, and there is hardly any rubber underneath the wedge shoe. When the loose wedge shoe is removed, it is obvious that water has been in contact with the wedge core as corrosion has occurred (#1 and 2).

When the core is vulcanised with rubber it must be supported. If the support points have not been covered with rubber, corrosion will start as soon as the valve is in contact with water (#4).



1



2



3

The wedge guide has an uneven rubber thickness which has resulted in an irregular load during operation. The rubber is destroyed, and the core has been exposed which has resulted in corrosion (#3).

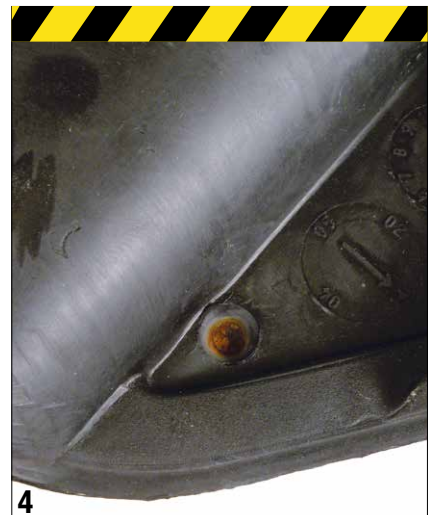

4

DOUBLE BONDING SECURES EXCELLENT RUBBER ADHESION



The quality of the bonding between the rubber and the wedge core is of vital importance. AVK uses a unique double bonding system that ensures optimum adhesion.



The wedge core is immersed in two different baths - the first to prepare the ductile iron core and the second to vulcanise the rubber to the core.

The rubber is vulcanised to the metal wedge core with a process that fully bonds the two materials. Even if a sharp object penetrates the rubber the bonding is so strong that there is no risk of creeping corrosion underneath the rubber. As a result, we can offer the best rubber adhesion and corrosion protection on the market.

Since no international bonding standard is available, AVK has developed its own harsh test method to ensure that the adhesion also withstands a worst-case scenario. Testing is done both during production and after immersion in 90°C water for 3 weeks. When peeling off rubber from the core, the core must still be covered with rubber.

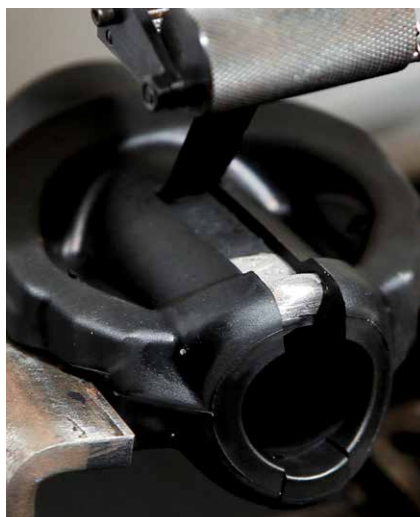

INFERIOR BONDING RESULTS IN CORROSION AND MALFUNCTION



A bonding test shows poor adhesion on a competitor wedge (1). This could be induced by wrong choice of bonding method or wrong processing.

Rubber is peeled off the metal core due to insufficient bonding on a competitor wedge (2).

A competitor wedge that is totally destroyed due to insufficient bonding and incorrect vulcanisation (3).



COMPRESSION SET ABILITY TO REGAIN ORIGINAL SHAPE



AVK's rubber compounds have an excellent compression set, which means the ability to recover the original shape after having been compressed.



Excellent ability to regain original shape

Even after many years of operation, tiny pebbles, sand and other impurities will not affect the rubber surface or the tightness of the valve. Unique AVK rubber compounds are applied to ensure that the wedge can absorb the impurities in closed position and is able to regain its original shape when it is opened again.

specific time. The pressure on the rubber is relieved and the layer thickness is measured after half an hour. The smaller the deformation, the better the memory effect.

$$\text{Compression set (S)} = \frac{d_0 - d_1}{d_0 - d_2}$$

d_0 = original thickness of the test specimen

d_1 = thickness of test specimen after test

d_2 = thickness of test specimen in compressed condition

Test method for permanent deformation

The rubber is deformed by 25% of its original thickness at a constant temperature for a

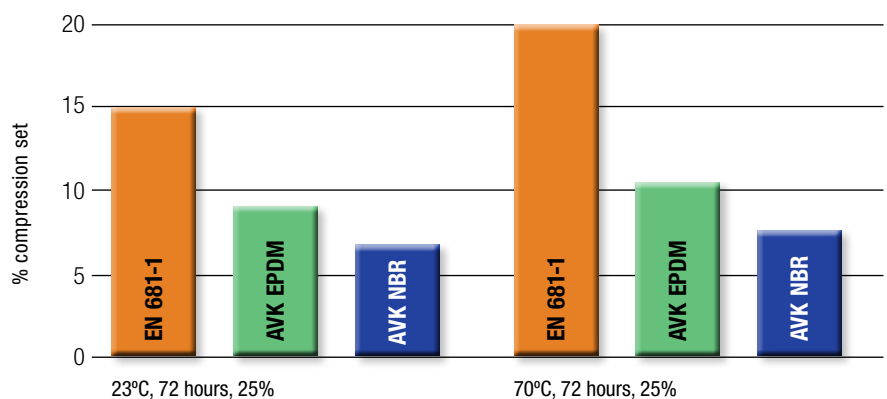

EN 681-1 states the minimum requirements for the compression set value. The smaller the permanent deformation, the better the compression set.

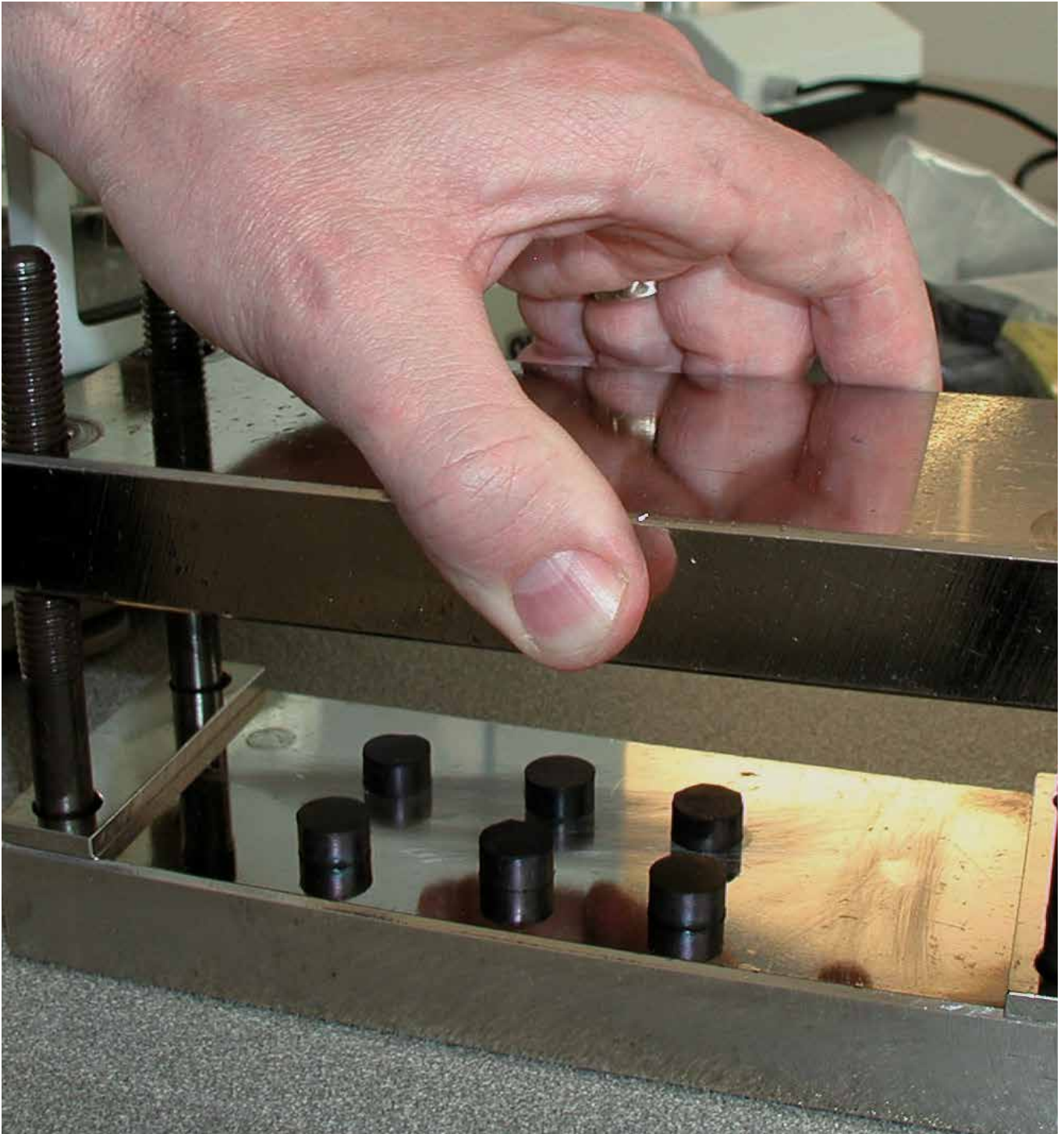

The picture shows a competitor wedge which has been damaged because of its failure to resist the closing torque. It can no longer close tightly, and the water now has free access to the wedge core resulting in corrosion attack.



RESISTANCE TO WATER TREATMENT CHEMICALS



Chlorine and other chemicals are commonly used to clean new pipelines or disinfect old ones. Ozone and chlorine may also be added in low concentrations to make the water drinkable. AVK has developed an EPDM rubber resistant to such water treatment chemicals.

Thoroughly tested rubber compounds

The rubber which is a complex formulation of many ingredients is developed and tested by AVK's own R&D scientists. For third party verification and approvals, we work only with recognised test institutes. AVK has the most advanced state of the art mixing facility which ensures repeatability and high performance materials.

Tests are continuously carried out to ensure that the correct rubber compound is applied for the right area of use, and that rubber used in drinking water does not give off taste, smell or colour. The rubber compounds are also ozone

tested as exposure to ozone tends to have a negative effect on NBR as an example.

Ozone resistance:

Ozonation is commonly used to reduce smell and taste or to reduce bacterial activity. The chemical reaction will also cause degradation of rubber materials, if such materials are not adequately formulated to encounter highly reactive chemicals such as ozone.

AVK's own compound EPDM is superior to any other material, including many other EPDM materials. The unique structure can withstand an extremely high concentration of ozone.

After 200 hours of exposure in 200 pphm the properties of AVK's EPDM have not changed, while both the SBR and NBR grade are suffering.

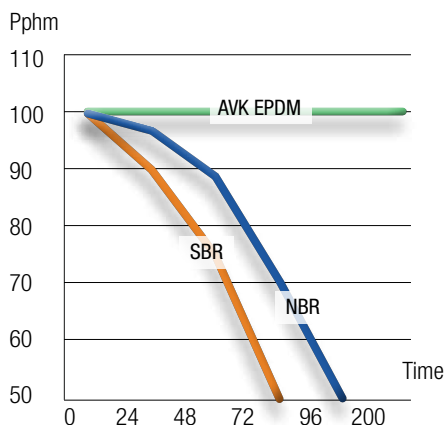

A competitor NBR wedge with ozone cracks. After one month, distinct cracks occur in the rubber. If these cracks occur in the sealing surface, it may result in creeping corrosion in the wedge core.

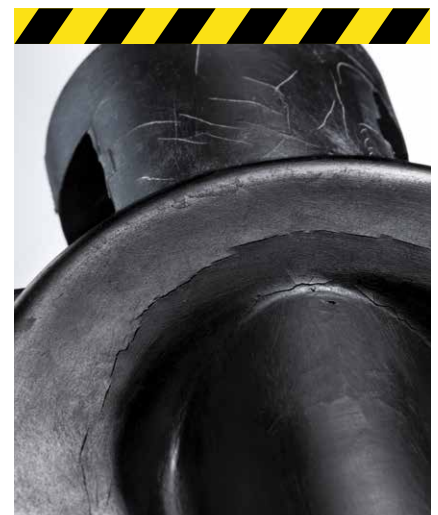



Chlorination

As chlorination of drinking water is common in most places it is important that the rubber is not affected by long time exposure. AVK has developed a series of EPDM compounds - here illustrated by AVK EPDM which is literally unaffected by even extreme concentration of sodiumhypochlorite (NaOCl) - a commonly used source for chlorination.

In the past, SBR was often used for wedges, as this material is tough and cost efficient. However, SBR is inferior to AVK's EPDM not least due to the poor resistance towards chlorination. NBR is often requested since this

rubber type may be used for both water and gas applications, provided that the compound has been approved accordingly. However, a compromise must be accepted as NBR - in this case AVK NBR - will also suffer.

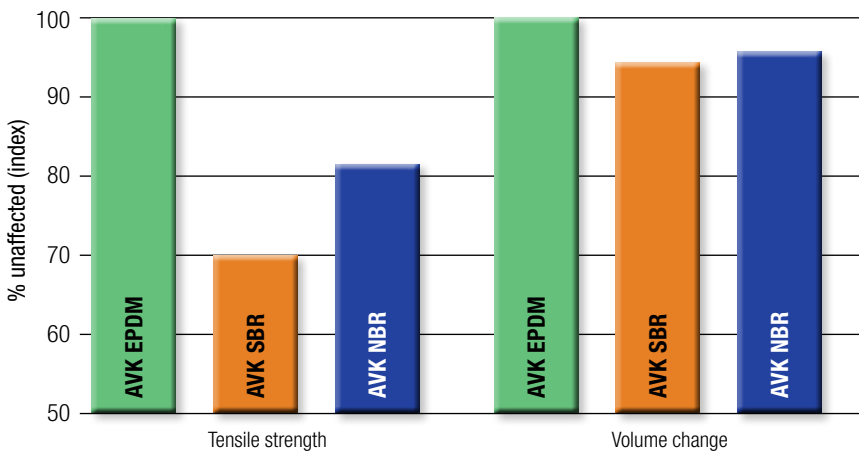

AVOID CONTAMINATION MINIMISE FORMATION OF BIOFILM

AVK's EPDM rubber recipes are composed with focus on minimising the formation of biofilm. The rubber will therefore not provide breeding ground for bacteria.

Formation of biofilm

Organic substances such as medicinal paraffinic oils and waxes migrate from the rubber compound. They act as nutrients for microorganisms, which will then start forming

biofilm. In the course of time, however, there will be fewer nutrients available, and the biofilm will decompose.

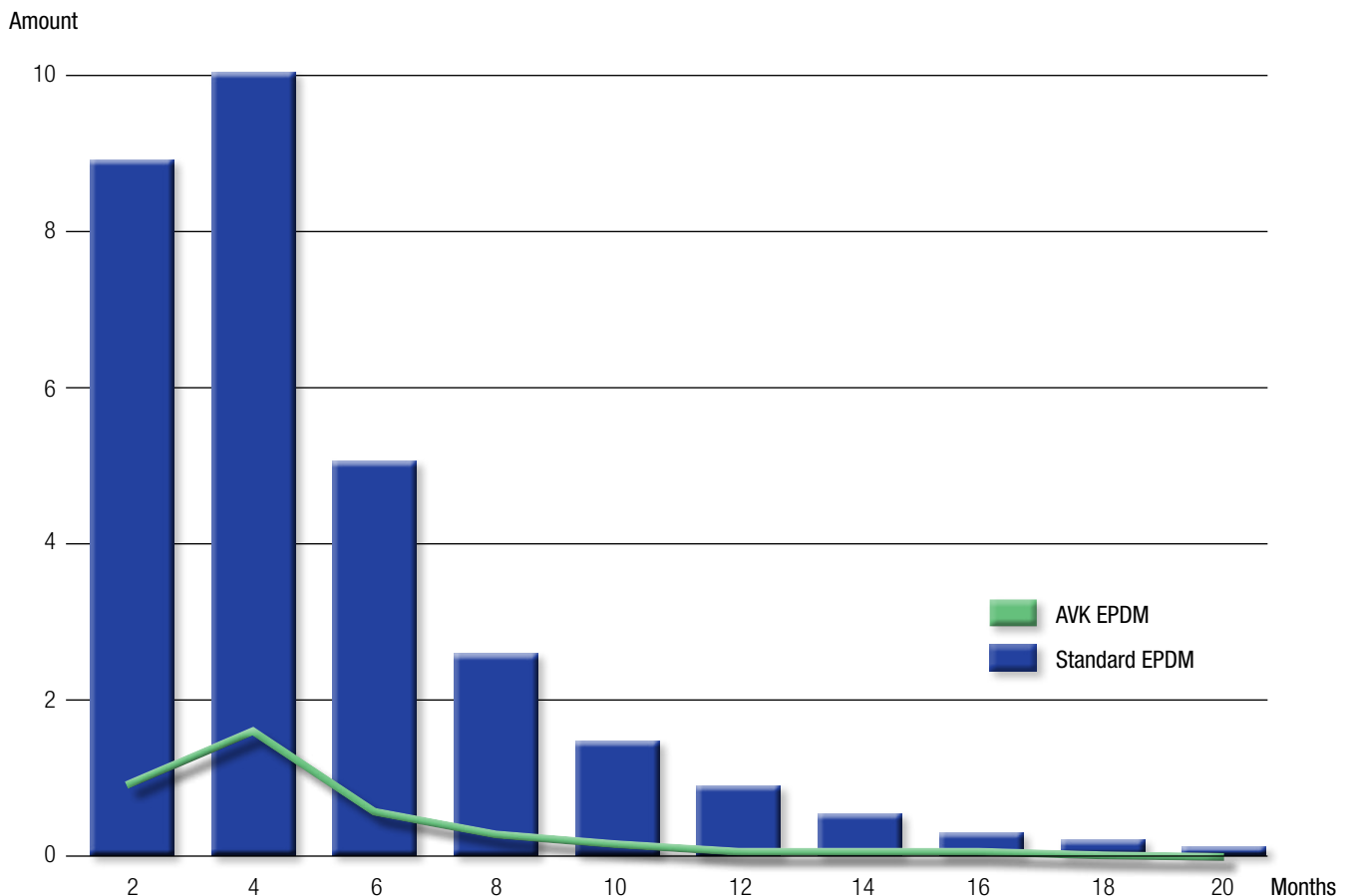



Competitor EPDM wedge after six months of operation - an example of microbiological growth on an improperly formulated rubber compound.



FEATURE SUMMARY DO NOT COMPROMISE WITH QUALITY



Go for a long-term solution and choose resilient seated gate valves from AVK with a high uniform quality and a maintenance and trouble-free operation.

Unique features and benefits

- Fixed, integral wedge nut sealed with rubber prevents corrosion (1).
- Double bonding vulcanisation process ensures maximum adhesion of the rubber.
- Guide rails with vulcanised wedge shoes ensure low friction and smooth operation (2).
- Rubber vulcanised to the core with min. 1.5 mm on all pressure bearing surfaces and 4 mm on all sealing surfaces gives optimum corrosion protection.
- Large rubber volume in the sealing area provides optimum sealing (3).
- Large plain stem hole (4) prevents stagnant water and accumulation of impurities.
- The rubber features an outstanding ability to regain its original shape.
- The rubber is resistant to water treatment chemicals.
- The rubber ensures minimum biofilm formation which prevents contamination of the drinking water.
- The rubber is approved for drinking water applications.

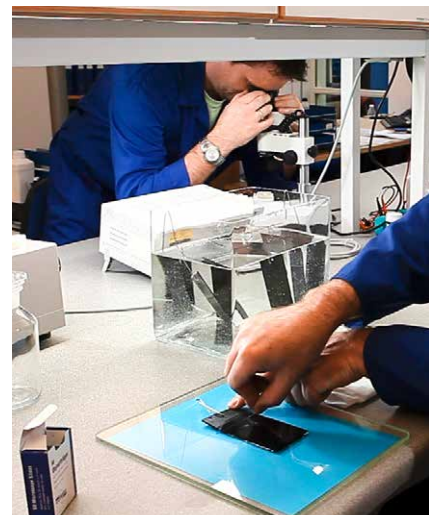



Standards and approvals

AVK produces according to all common national and international standards such as ISO, CEN, DIN, NF, BS, GB, AWWA, JWWA, SABS, AS and GOST.

All rubber compounds used in our products are manufactured by AVK GUMMI A/S whose quality management systems are certified in accordance with EN ISO 9001 and ISO/TS 16949. These systems include 100% control of each rubber compound, full traceability with the help of a batch number system, SPC control, FMEA and a zero defect production.

The rubber is manufactured for drinking water, food, healthcare and gas. A list of ingredients for each segment is formulated to secure that only the correct additives are used in the process. For drinking water applications, all rubber compounds are approved according to the following standards.

Approvals for drinking water:

Standards	Country
UBA / KTW	>> Germany
W 270	>> Germany
WRAS BS 6920	>> United Kingdom
ACS XP P 41-250	>> France
ANSI NSF-61	>> USA
AS/NZS 4020	>> Australia/New Zealand
SS 375	>> Singapore
JIS K6353	>> Japan
KIWA	>> The Netherlands
Norm B 5014	>> Austria
NBN S29003	>> Belgium
Hydrocheck	>> Belgium
CSN 75 7111	>> The Czech Republic
GB 4749	>> China

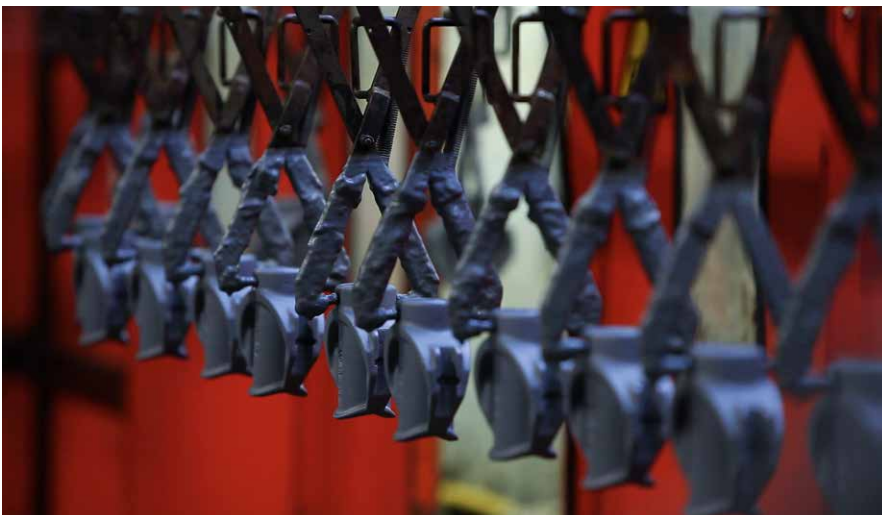



AVK International A/S

Bizonvej 1
Skovby
8464 Galten
Denmark

Tel.: +45 8754 2100
sales@avk.dk
www.avkvalves.eu

2019-01-15
Copyright © AVK Group A/S 2019

